

Thank you for purchasing a Sealey Product. Manufactured to a high standard this tool will, if used according to these instructions and properly maintained, give years of trouble free performance.



**IMPORTANT: PLEASE READ THESE INSTRUCTIONS CAREFULLY. NOTE THE SAFE OPERATIONAL REQUIREMENTS, WARNINGS AND CAUTIONS. USE THIS PRODUCT CORRECTLY AND WITH CARE FOR THE PURPOSE FOR WHICH IT IS INTENDED. FAILURE TO DO SO MAY CAUSE DAMAGE AND/OR PERSONAL INJURY AND WILL INVALIDATE THE WARRANTY. PLEASE KEEP INSTRUCTIONS SAFE FOR FUTURE USE.**

## 1. SAFETY INSTRUCTIONS

- WARNING! DO NOT** use the torque wrench if damaged or thought to be faulty.
- ✓ Ensure all workshop safety rules, regulations and conditions are complied with when using the torque wrench.
- ✓ Maintain correct balance and footing. Ensure the floor is not slippery and wear non-slip shoes.
- ✓ Keep children and unauthorised persons away from the working area.
- ✓ Avoid over-torquing the wrench (110% of maximum torque range) as this will cause loss of accuracy.
- ✓ Keep the wrench away from magnets.
- x **DO NOT** use the wrench as a hammer or similar.
- x **DO NOT** subject the wrench to excessive force or shocks.
- x **DO NOT** drop, throw, or violently shake the wrench.
- x **DO NOT** operate the wrench in damp conditions.
- x **DO NOT** operate the wrench in dusty conditions.
- x **DO NOT** push on the LCD panel.
- x **DO NOT** use wrench until first instructed in its use by a qualified person.
- x **DO NOT** leave the wrench in a place exposed to excessive heat, humidity or direct sunlight.
- x **DO NOT** use organic solvents such as alcohol or thinners to clean the wrench.
- ✓ After use, clean with a soft dry cloth, place torque wrench in its storage case, and store in a safe, dry, childproof location.

## 2. INFORMATION & SPECIFICATION

Rugged and resilient digital torque wrench suitable for workshop and factory use. LCD read-out with LED/audible alarm indicates achieved and target torque levels. Features angle mode, eliminating the need for angle gauges and protractors providing the most accurate and fastest way to measure torque plus angle tightening sequences. Will also accumulate angle measurement when multiple turns are required, ideal for when access is limited. Preset desired torque levels or track peak and working torques using simple push-button menu. Selectable read-out in Nm, lb.in, lb.ft, kgf.m or degrees. Reversible Chrome Vanadium 72-tooth ratchet allows torque reading in either direction. Accurate to  $\pm 2\%$  between 10% and 100% of wrench's stated capacity. Supplied with test certificate and storage case.

### 2.1 Specification.

Drive: . . . . .  $\frac{1}{2}$ "Sq  
 Overall Length: . . . . . 610mm  
 Angle Range: . . . . .  $1^\circ - 360^\circ$   
 Torque Range: . . . . . 20 - 200Nm  
 Torque Range: . . . . . 15 - 148lb.ft  
 Torque Range: . . . . . 177 - 1770lb.in  
 Torque Range: . . . . . 2 - 20kgf.m  
 Accuracy: . . . . .  $\pm 2\%$   
 (Clockwise and anti-clockwise of reading, 10% - 100% of full scale)

### 2.2 Re-calibration.

In order to ensure continued accuracy, the wrench should be re-calibrated annually and also after any impact, over-torquing or other misuse. Contact your authorised Sealey dealer to arrange this.

### 2.3 Repair Kit available.

Part No: STW306.RK  
 Contact your authorised Sealey dealer.

## 3. SET-UP

### 3.1 Installing batteries.

- 3.1.1 Unscrew the battery compartment cap anti-clockwise
- 3.1.2 Insert four new AAA size batteries (positive end first) into the compartment. Push the battery cap on against the spring and screw clockwise to lock

**Note:** If the wrench is not to be used for an extended period, remove the batteries before storage. Do not mix types of battery, or used and new ones. Keep battery terminals clean.

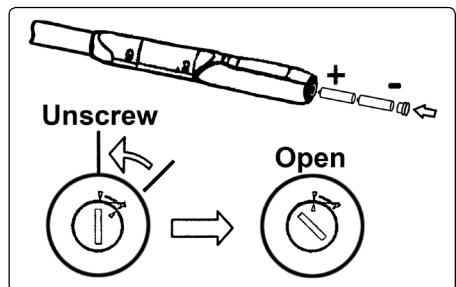

If the battery voltage is low, the battery symbol will be displayed on the screen and soon afterwards, the wrench will turn off. Replace with a new set of batteries.

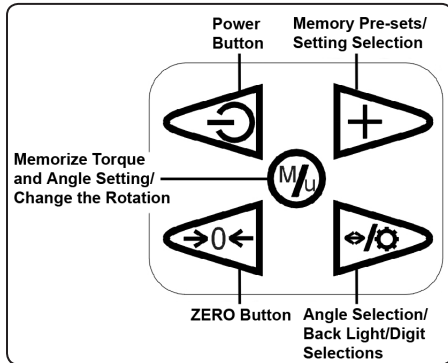

### INITIAL OPERATION:

#### 3.2 Power On.

- 3.2.1 Place the wrench on a horizontal level surface and press the button to turn on the torque wrench.
- 3.2.2 Press the button again to turn the wrench off.

### SET-UP

- 3.3 **Track Mode:** After turning on the torque wrench it will be set in 'track' mode.

This means once the torque is reached and pressure is taken off the torque wrench the display rolls back down to ZERO.

- 3.4 **Peak Hold Mode:** Use the wrench in exactly the same way, except that when the force is released, the display stays at the maximum torque that has been applied. After two seconds the display will flash. Either continue on the next operation or press the button to ZERO the value and continue onto the next operation.

#### 3.5 Track and Peak Mode Setting.

- 3.5.1 Press the button to turn the wrench on.
- 3.5.2 Press the button to enter mode selection.
- 3.5.3 Press the button to select:



- 3.5.4 To confirm, press the button.
- Note: If no buttons are pressed within 3 seconds the display will return to the main screen.**
- 3.5.5 After confirming, the screen will automatically move onto the next setting (Unit selection).

#### 3.6 Unit Selection.

- 3.6.1 When the peak or track mode has been confirmed the wrench will go to unit selection.

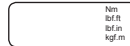

- 3.6.2 Nm will be shown, Press the button to scroll through different measurements.
- 3.6.3 Press the button to confirm.
- Note: If no buttons are pressed within 3 seconds the display will return to the main screen.**
- 3.6.4 After confirming, the screen will automatically move onto the next setting (Auto Power Off).

#### 3.7 Auto Power Off

- 3.7.1 When the unit selection has been confirmed the wrench will go to Auto Power Off setting.
- 3.7.2 On the auto power off screen the default time will be shown (5 minutes).
- 3.7.3 Press the button to scroll through the settings.

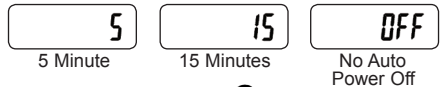

- 3.7.4 To confirm, press the button.
- Note: If no buttons are pressed within 3 seconds the display will return to the main screen.**
- 3.7.5 After confirmation, the screen will return to the main screen.

### PROGRAMMING THE TORQUE AND ANGLE.

The wrench has the ability to hold 5 torque and angle settings in its memory

#### 3.8 Torque Setting

- 3.8.1 Press the button to turn the wrench on.
- 3.8.2 Press the button to scroll through the memory storage numbers M1 - M5



- 3.8.3 After choosing which memory slot to use hold down the button for 2 - 5 seconds.
- 3.8.4 Release the button when 'SET' is shown on the screen.

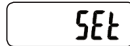

- 3.8.5 The last saved torque will be shown.
- 3.8.6 Press the button to ZERO the figures.
- 3.8.7 Press the button to change each digit in turn, press the button to move between digits.
- 3.8.8 To confirm the torque figure is set, press the button. Setting the angle will proceed.

- Note: If no buttons are pressed within 6 seconds the display will continue to the angle setting.**
- Note: 'Erro' will be shown on the screen if the torque set does not fall between 10% and 100% of the range of the wrench.**

### 3.9 Angle Setting.

- 3.9.1 When the torque setting has been confirmed the wrench will go to angle setting.

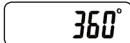

- 3.9.2 The last saved angle will be shown.  
3.9.3 Press the button to ZERO the figures.  
3.8.4 Press the button to change each digit in turn, press the button to move between digits.  
3.9.5 When the angle figure is set, press the button to confirm.

**Note: If no buttons are pressed within 6 seconds the display will return to the main screen.**

**Note: 'Erro' will be shown on the screen if the angle set does not fall between 1° and 360°.**

## 4. OPERATION

### 4.1 Display Back-light.

- 4.1.1 Press and hold the button for 5 seconds.

### 4.2 Torque Measurement.

- 4.2.1 Select the correct size socket and snap it onto the wrench.  
4.2.2 Press the button to scroll through the pre-set torque figures (M1-M5).  
4.2.3 Place the wrench onto a nut/bolt and begin to tighten, use a smooth motion and avoid jerky movements.

### 4.3 LED and Buzzer Indicators - Torque.

- 4.3.1 When under 50% of the set torque, the LED will flash GREEN.  
4.3.2 After 50% of the torque figure has passed the LED will change to a solid YELLOW.  
4.3.3 5Nm (or equivalent value) from the set torque the buzzer will sound.  
4.3.4 The LED will change to RED when you are within 2% of the set torque.  
4.3.5 When the set torque is reached the buzzer will become quicker.  
4.3.6 If you go over the set torque the wrench will emit a continuous tone and the LED will turn back to GREEN.

### 4.4 Angle Measurement.

- 4.4.1 Press the button to switch to angle measurement.  
4.4.2 Select the correct size socket and snap it onto the wrench.

- 4.4.3 Press the button to scroll through the pre-set angle figures (M1-M5).  
4.4.4 Place the wrench onto a nut/bolt and begin to tighten, use a smooth motion and avoid jerky movements.  
4.4.5 To change the direction from clockwise to anti-clockwise press the button. A minus symbol will appear on the display.

### 4.5 LED and Buzzer Indicators - Angle.

- 4.5.1 When under 50% of the set angle, the LED will flash GREEN.  
4.5.2 After 50% of the angle figure has passed the LED will change to a solid YELLOW.  
4.5.3 The LED will change to RED when you are within 2% of the set angle.  
4.5.4 When the set torque is reached the buzzer will emit a continuous tone.  
4.5.5 If you go over of the set angle by 2% the LED will turn back to GREEN.  
4.5.6 Press the button to ZERO the angle for another reading. The below will display.

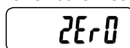

- 4.5.7 When all angle measurements are done, press the button to switch back to torque measurement.

#### Environmental Protection.



Recycle unwanted materials instead of disposing of them as waste. All tools, accessories and packaging should be sorted, taken to a recycle centre and disposed of in a manner which is compatible with the environment.



When the product is no longer required, it must be disposed of in an environmentally protective way.

#### Battery Removal.



Refer to section 3.1 for battery removal. **Dispose of batteries according to local authority guidelines.**

Under the Waste Batteries and Accumulators Regulations 2009, Jack Sealey Ltd are required to inform potential purchasers of products containing batteries (as defined within these regulations), that they are registered with Valpak's registered compliance scheme.  
Jack Sealey Ltd's Batteries Producer Registration Number (BPRN) is BPRN00705

**NOTE:** It is our policy to continually improve products and as such we reserve the right to alter data, specifications and component parts without prior notice.

**IMPORTANT:** No liability is accepted for incorrect use of this product.

**WARRANTY:** Guarantee is 12 months from purchase date, proof of which will be required for any claim.

**INFORMATION:** For a copy of our latest catalogue and promotions call us on 01284 757525 and leave your full name and address, including postcode.



Sole UK Distributor, Sealey Group,  
Kempson Way, Suffolk Business Park,  
Bury St. Edmunds, Suffolk,  
IP32 7AR



01284 757500



www.sealey.co.uk



01284 703534



sales@sealey.co.uk